

99275

Dimensions

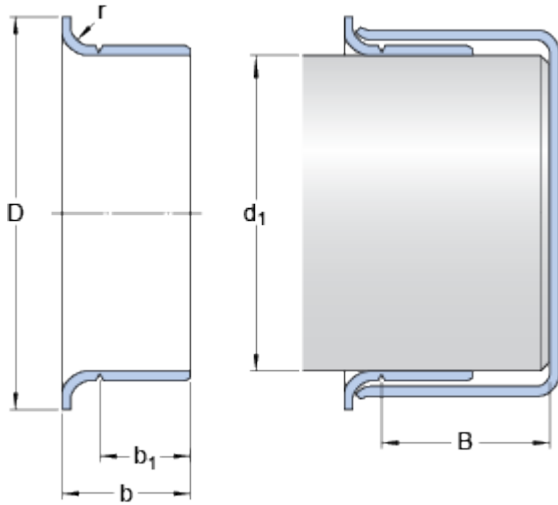

Nominal dimensions

d_1		70	mm
D		79.375	mm
Tolerance outside diameter D	\pm	1.6	mm
b		23.825	mm
Tolerance width b	\pm	0.8	mm
b_1		19.837	mm
Tolerance width b_1	\pm	0.8	mm
B	max.	31.75	mm
r	max.	3.18	mm

Shaft diameter range

d_1	min.	69.85	mm
d_1	max.	70.028	mm